

T7335A, B, C, D, E

THERMISTOR TEMPERATURE SENSOR

PRODUCTION HANDBOOK

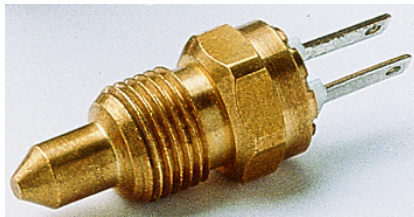

T7335A series



T7335B series

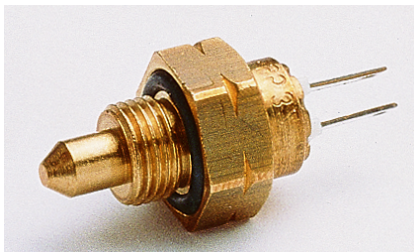

T7335C series

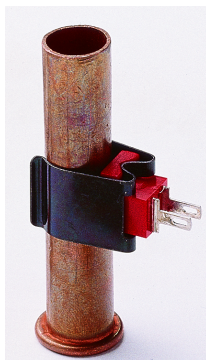

T7335D series

APPLICATION

The T7335 thermistor temperature sensors are for use with electronic boiler controls.

The T7335 thermistor temperature sensors provide an electrical signal to the boiler control.

The T7335A,C thermistor temperature sensors are direct immersion type sensors.

The T7335B thermistor temperature sensors are intended for use in tube well assemblies to measure temperature in storage tanks etc.

T7335D sensors allow quick mounting and do not require draining of the system when replacing.

Contents

General	page
Description	2
Features	3
Technical	
Specifications sensing element	4
Temperature sensor performance specifications	6
Test conditions	7
Dimensions and mounting T7335A/C	8
Specifications, dimensions and drawing T7335B	9
Dimensions and drawing T7335D	10
Used material	12
Various	
Application notes	12
Steinhart and Hart equation	13
Standards and approvals	13
Ordering information	14
Accessories	14

DESCRIPTION

The T7335 series thermistor temperature sensor consists of a packaged temperature dependent resistor.

The T7335 series thermistor temperature sensor are mainly intended for water temperature measurement in domestic boiler appliances and heating systems. Here they are used in combination with electronic controls. See fig. 10. page 14

The temperature dependant resistor is a **Negative Temperature Coefficient thermistor (NTC)** which is a ceramic resistor of which the resistance value drops as the temperature increases.

The T7335 series thermistor temperature sensor can be delivered with various standard temperature curves. (See table 1., page 4 and table 2. page 5)

FEATURES

General

The T7335 series are available as direct immersion sensors, well immersion sensors and surface mount sensors. The sensors are available with various NTC and shape combinations.

T7335 A/C.... Direct immersion sensors

The sensors are used in applications where the best available response time and accuracy is important.

They are suitable for both domestic hot water and central heating water measurement.

This type of sensor consists of a dezincification resistant brass housing with thermoplastic insert where the NTC resistor is mounted.

The T7335A series use a metal to metal seal as its media seal.

The T7335C sensors use a sealing ring for this purpose.

The sensors have 2.8 x 0.5-mm quick-connect terminals for electrical connection.

T7335 B.... Well immersion sensors

This type of sensor is intended for use in tube well assemblies to measure temperature in storage tanks etc.

Another application is as a thermal backdraft-measuring sensor. When compared to direct immersion sensors, these sensor have slower response times, but allow for higher electrical isolation values.

The sensors are made of a copper tube where the NTC sensor is potted in, connected to a cable with either stripped ends or a connector.

Various cable types, connector types, and tube dimensions are available.

T7335 D.... Surface mount sensors

This type of sensor allows quick mounting and do not require draining of the system when replacing.

The performance of this sensors is more dependent on the application when compared to direct immersion sensors. Typically, response time will be comparable to direct immersion sensors, but temperature offset will be higher and have a greater unit to unit variation.

They are constructed using a plastic housing with a thin metal shoe where the NTC sensor is attached.

The sensors have 2.8 x 0.5-mm quick-connect terminals for electrical connection

T7335 E.... Special type sensors

This type of sensor is for specific customer applications that do not fit into the other series.

They are not covered by this handbook, but documented separately.

SPECIFICATIONS SENSING ELEMENT

Sensing element

The sensing element is a NTC thermistor that is used in the temperature sensor assembly.

Nominal resistance characteristics

The following temperature characteristics are available. In this table, the sensitivity α is the percentage change in resistance of the sensing element per °C temperature change at the specified temperature. Other values may be calculated using the Steinhart & Hart coefficients as described on page 15.

Table 1: Temperature characteristics 2.7k, 10k-A, 10k-B and 12k-A

Steinhart & Hart Coeff.	Curves							
	2.7k		10k-A		10k-B		12k-A	
C	1.94567E-18		8.77547E-08		1.89916E-07		1.28318E-07	
B	2.51842E-04		2.34108E-04		2.52293E-04		2.40423E-04	
A	1.36421E-03		1.12924E-03		8.84204E-04		9.89458E-04	
f	1		1.01707E+00		1		1	
T [°C]	R [Ω]	α [1/°C]	R [Ω]	α [1/°C]	R [Ω]	α [1/°C]	R [Ω]	α [1/°C]
-20	29.30k	-6.2%	98.66k	-5.8%	67.38k	-4.8%	98.97k	-5.4%
-10	16.14k	-5.7%	56.25k	-5.4%	42.14k	-4.6%	58.88k	-5.0%
0	9.292k	-5.3%	33.21k	-5.1%	27.06k	-4.3%	36.13k	-4.7%
10	5.561k	-5.0%	20.24k	-4.8%	17.82k	-4.1%	22.80k	-4.5%
20	3.446k	-4.6%	12.71k	-4.5%	12.00k	-3.8%	14.77k	-4.2%
25	2.746k	-4.5%	10.17k	-4.4%	9.92k	-3.7%	12.00k	-4.1%
30	2.205k	-4.3%	8.194k	-4.3%	8.251k	-3.6%	9.804k	-4.0%
40	1.451k	-4.0%	5.416k	-4.0%	5.786k	-3.5%	6.652k	-3.8%
50	980.1	-3.8%	3.663k	-3.8%	4.132k	-3.3%	4.607k	-3.6%
60	677.8	-3.6%	2.530k	-3.6%	3.000k	-3.1%	3.252k	-3.4%
70	478.9	-3.4%	1.782k	-3.4%	2.213k	-3.0%	2.337k	-3.2%
80	345.1	-3.2%	1.278k	-3.2%	1.656k	-2.8%	1.707k	-3.1%
85	295.0	-3.1%	1.089k	-3.2%	1.441k	-2.8%	1.467k	-3.0%
90	253.2	-3.0%	931.6	-3.1%	1256.9	-2.7%	1.266k	-2.9%
100	188.9	-2.9%	690.0	-2.9%	965.9	-2.6%	952.3	-2.8%
110	143.1	-2.7%	518.5	-2.8%	751.2	-2.5%	726.0	-2.6%
120	109.9	-2.6%	395.0	-2.7%	590.8	-2.3%	560.4	-2.5%
125	96.83	-2.5%	346.4	-2.6%	526.0	-2.3%	494.6	-2.5%

Table 2: Temperature characteristics 100k-A and 1M-A

Steinhard & Hart Coeff.	Curves			
	100k-A		1M-A	
C	8.05920E-08		8.21658E-08	
B	2.08802E-04		1.67466E-04	
A	8.27111E-04		8.23774E-04	
f	1		1	
T [°C]	R [Ω]	α [1/°C]	R [Ω]	α [1/°C]
-20	1.107 M	-6.1%	14.29M	-6.7%
-10	612.4k	-5.7%	7.478M	-6.3%
0	351.0k	-5.4%	4.050M	-6.0%
10	207.8k	-5.1%	2.264M	-5.7%
20	126.7k	-4.8%	1.304M	-5.4%
25	100.0k	-4.7%	1.000M	-5.2%
30	79.43k	-4.5%	771.7k	-5.1%
40	51.06k	-4.3%	468.5k	-4.9%
50	33.60k	-4.1%	291.3k	-4.6%
60	22.59k	-3.9%	185.2k	-4.4%
70	15.50k	-3.7%	120.2k	-4.2%
80	10.84k	-3.5%	79.59k	-4.0%
85	9.12k	-3.4%	65.21k	-3.9%
90	7.708k	-3.3%	53.66k	-3.9%
100	5.573k	-3.2%	36.80k	-3.7%
110	4.090k	-3.0%	25.65k	-3.5%
120	3.045k	-2.9%	18.15k	-3.4%
125	2.640k	-2.8%	15.36k	-3.3%

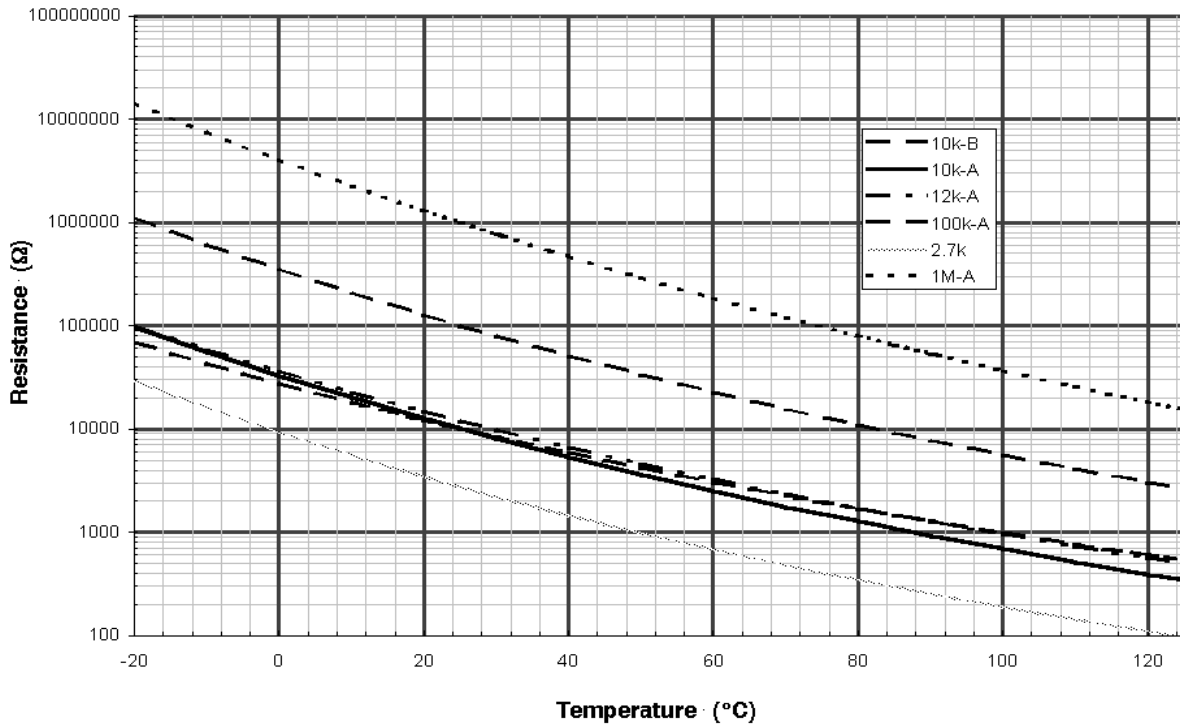

Fig. 1. Nominal resistance characteristics

TEMPERATURE SENSOR PERFORMANCE SPECIFICATION

Accuracy

The rated accuracy is the maximum deviation of the sensing element at a rated temperature. See table 6.

Thermal constant

The thermal time constant is the time required for the temperature of a thermistor to change at 63.2% of the difference between its initial and final temperature when the temperature changes stepwise.

Static temperature offset

The static temperature offset is the temperature loss that is caused by the heat flow from water to ambient temperature. The offset value is approximately proportional with the difference in temperature between ambient and water temperature Δt_{a-w} .

It is expressed as the difference in temperature as measured by a calibrated, assembled sensor and the actual water temperature after the temperature reading has stabilized at a given Δt_{a-w} .

Table 3:

Item	T7335A.../C....	T7335C 2036	T7335B....	T7335D....
Accuracy	2K at 25°C 1K at 100°C	0.2K at 0...50°C	See page 26	2K at 25°C 1.5K at 80°C
Time constant ¹⁾	< 6 s typical.		< 20 s in aquastat well	< 3 s typical
Temperature offset ¹⁾	< 1K at 60 K _{Δta-w}	< 0.5K at 60 K _{Δta-w}	n.a.	< 4K at 60 K _{Δta-w}
Operating Temperature	-20...125			-20...110°C
Maximum temperature	140 _C			125 _C
Thermal conductance	≥ 100 mW/K at 100 _C when immersed in water.			n.s.
Insulation Voltage	500 Vac		1500 Vac	500 Vac 1500 Vac for 1 MΩ version

¹⁾ The measured performance data can be very dependent on the test conditions; care should be taken to reproduce the appropriate test conditions, see page 24

Operating temperature range

The operating temperature range is the temperature range in which the sensing element is able to operate, within the tolerances specified accuracy and life endurance.

Maximum temperature

The maximum temperature is the highest allowable temperature that will not damage the element. The sensor shall be less than 5 minutes above the maximum operating temperature as in Thermal conductance (G_{th-w})

Thermal conductance

The thermal conductance is the power dissipation in a thermistor that causes a body temperature change of 1K with regard to a specified ambient temperature.

Table 6. Performance data temperature sensor

TEST CONDITIONS

T7335A.../C... (direct immersion)

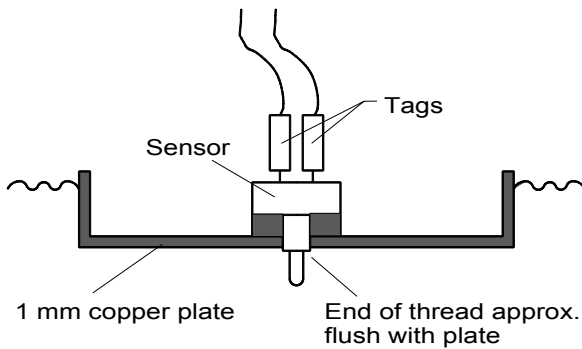

Fig. 2. Test setup for direct immersion sensors

Using two water baths at fixed temperatures tests screw-in type sensors. The sensor is inserted in a test rig and immersed in the water as shown in fig. 2.

The tests are performed at room temperature.

The total sensor accuracy is determined by measuring the sensor resistance when its value is stabilized.

After converting to temperature, it is compared to the actual water temperature.

The time constant is tested by quickly moving the test rig from one water bath to the another and plotting the sensor resistance against time. The time constant is then derived by converting the resistance values to temperatures and then reading the time required to reach 63.2% of the difference between the starting value and the end value.

To measure static temperature offset, the sensor is placed in an oven at the same temperature as the water bath so that heat is applied from all directions and the resistance readout has stabilized. After converting to temperature, it is compared to the actual oven temperature.

The static temperature offset is then given as:

$$\Delta T_{\text{static}} = \Delta T_{\text{water bath}} - \Delta T_{\text{oven}}$$

T7335B... Well immersion

The time constant is tested by fully immersing the sensor in the two water baths as for the T7335A.../C... types.

The immersion depth should be at least 100 mm. Because of this, the temperature offset will be negligible.

T7335D... surface mount

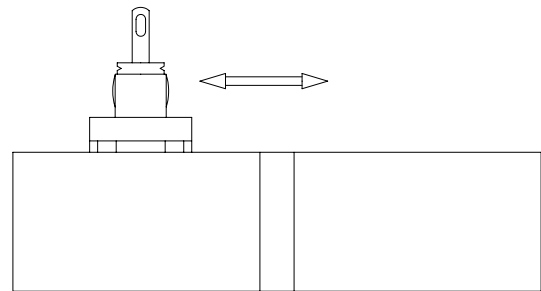

Fig. 3. Test setup for surface mount sensors

The time constant is tested by using a test rig with two surfaces instead of the water baths. The sensor is mounted in such a way that it can be moved quickly from one surface to the other. All comparisons and measurements use the surface temperature as the reference temperature; thus, the indicated value of the time constant does not take into account the heating effects of the surface itself. Otherwise, the test conditions and methods are similar to T7335A/C types.

DIMENSIONS AND MOUNTING T7335A/C

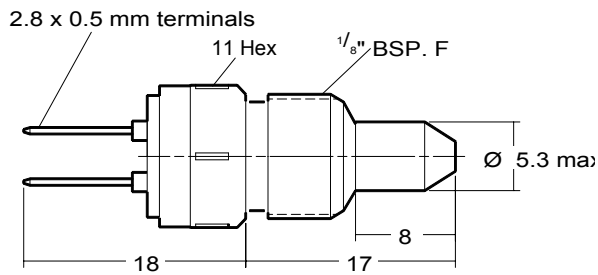

Fig. 4. T7335A

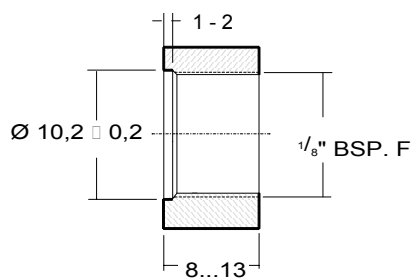

Fig. 5. Mounting hole dimensions for T7335A/C

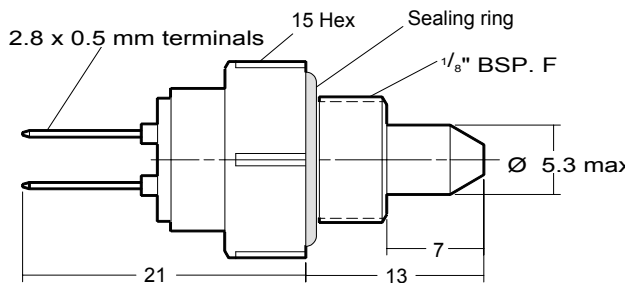

Fig. 6. T7335C

Mounting

Location

The T7335A/C sensor should be located in a position where it can detect a representative water flow temperature.

Mounting

- Drain water from the system.
- Mount the sensor in a properly dimensioned mounting hole according fig 5.
For the T7335A there is no sealing material necessary
Tightening torque 8...12 Nm.
- Refill the system with water and test for tightness.

SPECIFICATIONS, DIMENSIONS AND MOUNTING T7335B

Specifications

Lead wire

PVC isolated 0.5 or 0.75 mm² , 105°C max.

Cable end

Standard: stripped with butt-end splice

Optional: connector

Diameter copper tube

Standard: 6 mm

Optional: 4.76 mm and 5 mm

Length (depending on O.S. number; see fig. 7.)

L₁ = overall length

L₂ = tube length

Temperature curve depending on O.S. number

10k-A, tolerances: ± 2 K at 25°C;

± 1 K at 100°C

12k-A, tolerances: ± 2 K at 25°C;

± 1 K at 100°C

1M-A, tolerances: ± 1.2 K at 70°C;

± 2.2 K at 100°C

Mounting

Sensor should be pushed to the bottom of sensing well.

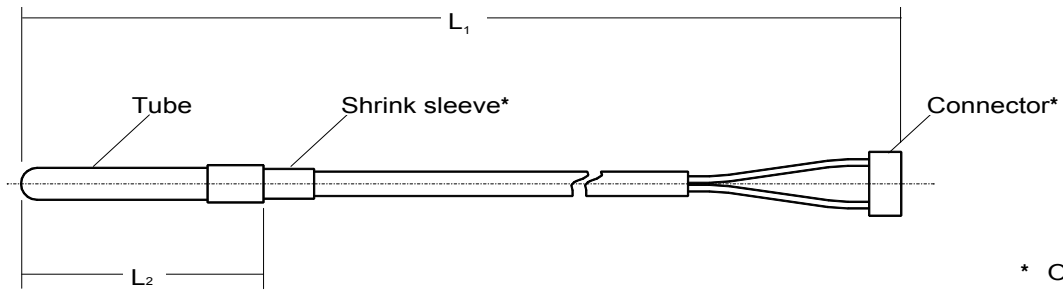

* Optional

Fig. 7. T7335B

DIMENSIONS AND MOUNTING T7335D

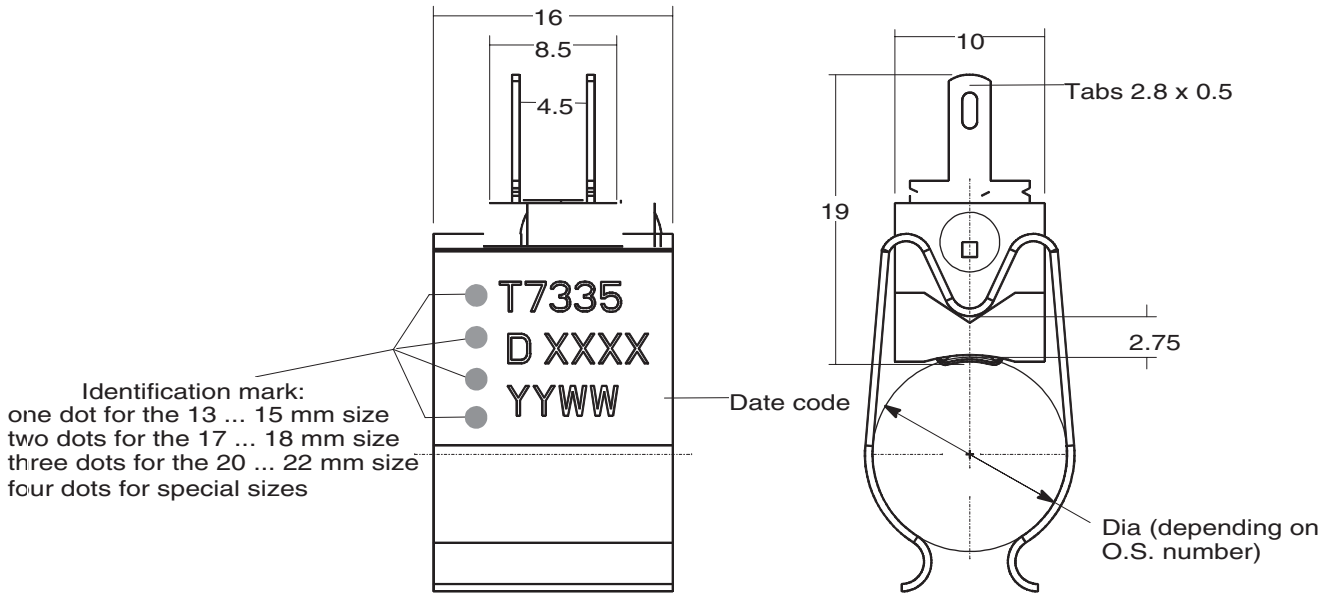

Fig. 8. Dimensions T7335D pipe mounted versions

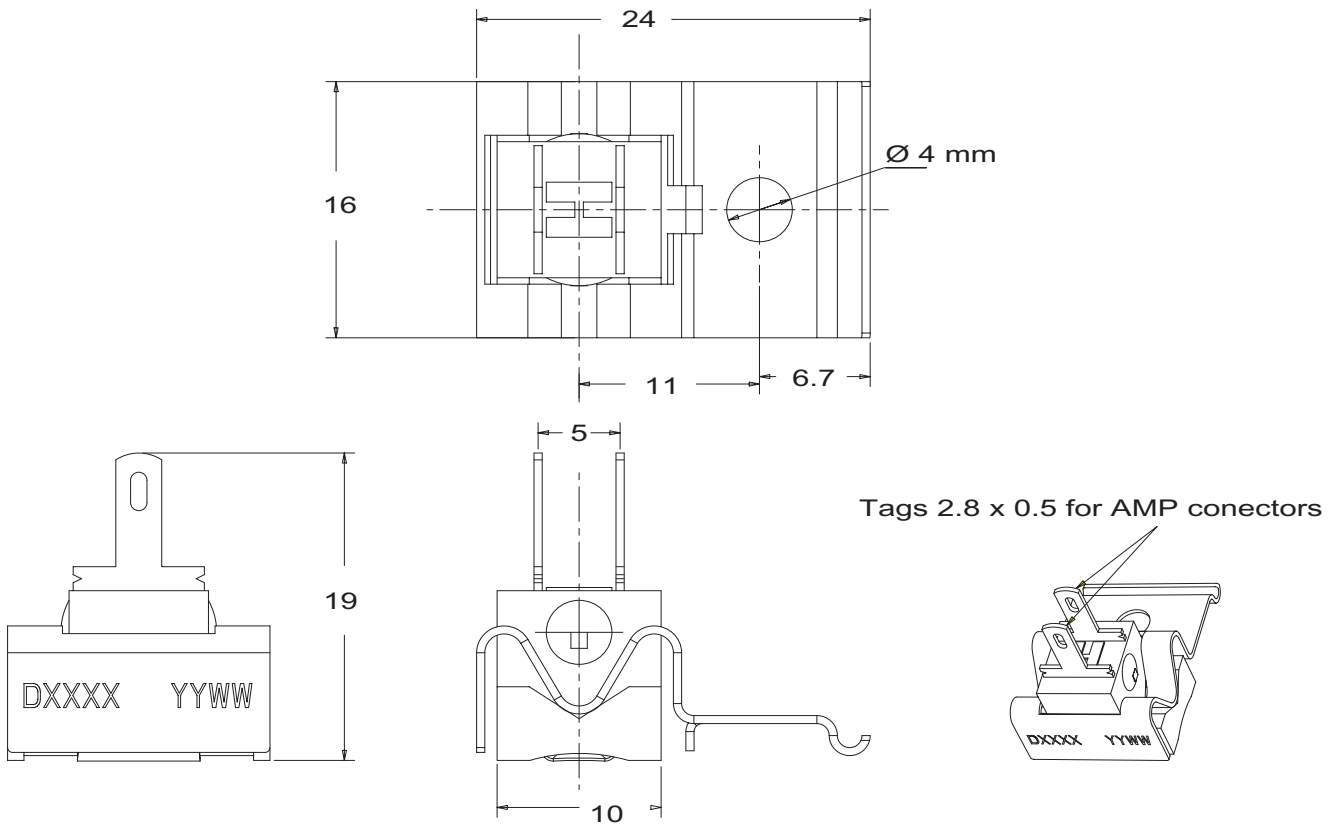

Fig. 9. Dimensions T7335D flat surface mounted versions

Mounting

Location

The T7335D sensor should be located in a position where it can detect a representative water flow temperature.

Pipe mounted versions

Make sure the sensor is fitted with the clip corresponding to the pipe diameter.

Do not unmount the pipe sensors by pulling the sensor wires.

Flat surface mounted versions



CAUTION

Due to the number of different materials and possible environments involved, it is impossible to guarantee the corrosion resistance of this sensor type in all applications.

Honeywell has tested the corrosion resistance of the sensor using a zinc passivated thread forming screw on Copper, Cast Iron, AlSi10 and Al1Si8Cu3 aluminum's under damp conditions.

However, it is strongly advised to verify the corrosion properties in the actual application, especially when mounting to other materials or when using different screws.

ELECTRICAL CONNECTIONS



CAUTION

Switch off power supply before making electrical connections.
Take care that wiring is in accordance with applicable electrical codes and local regulations.
Ensure that the connections are electrically and mechanically sound.

The T7335A/C/D sensors provide basic insulation between terminals and housing.

The T7335A/C/D sensors with a resistance of 10 k Ω or 12 k Ω should be used in SELV circuits (see EN 60335 clause 2.5.2).

The T7335A/C/D sensors with a resistance of 1 M Ω can also be connected via protective impedance (see EN 60335 clause 2.10.3)

NOTE: If the appliance is tested for electrical strength, the T7335A/C sensors with a resistance of 1 M Ω should be disconnected before conducting the test (see EN 60335 clause 13.1).

Wiring

- Use leadwire with good quality isolation which is suitable for the temperatures encountered.
- The temperature sensors are provided with quick connect terminals which are suitable for 2.8 x 0.5 mm receptacles (e.g. series "110" AMP fasteners).
- Connect temperature sensor to the electronic control.

USED MATERIAL

Used materials

NTC: metal oxides compound, coated with epoxy resin.

T7335A/C series

Housing: dezincification resistant brass

“O”-ring (T7335C-series only): EPDM rubber

Terminals: brass, tin plated.

Plastic parts: thermoplastic PBT

This sensor can be use with potable water, all parts in direct contact with water are made of WRC approved materials.

T7335B series

Housing: copper with potted NTC using Epoxy resin.

Cable: PVC isolated 0.5 or 0.75 mm² ,105 °C max.

Connector: depending on O.S. number

T7335D series

Housing: thermoplastic PA

Terminals and shoe: brass, tin plated.

Clips: zinc electroplated spring steel.

APPLICATION NOTES

General

The T7335 sensors are all based on NTC thermistor sensing elements.

The NTC is characterized by an approximately exponential resistance decrease when its temperature rises. See fig. 10

NTC's offer the highest available sensitivity to temperature changes when compared to other temperature sensing devices with similar accuracy and costs. They also offer excellent long term stability. This enables good control at low system cost for boiler applications.

NTC sensors are usually referenced by their nominal value at 25°C, although this information does not completely define the NTC's nominal resistance curve.

The exact nominal resistance curve is defined by the so-called Steinhart and Hart equation, see page 15 for details.

Intended applications

The T7335 sensors are primarily designed to measure water temperature in boiler applications:

- Controlling the heating circuit water temperature in central heating systems.
- Controlling the domestic hot water temperature in water heaters.
- Controlling both the heating circuit water temperature and the domestic hot water temperature in combi-boiler appliances.

Normally, the sensor is connected to an electronic control that modulates or switches a gas valve.

For these application, the most important aspects of the system are the repeatability and the responsiveness of the controlling system to temperature changes.

The T7335A/C and D series have been optimized to these aspects.

The T7335B.... series were designed for uses where lower response time is not a problem.

These are typically switching applications where water temperature is measured in storage tanks.

Another application for the T7335B.... series is an atmospheric burner appliance where a device must prevent spillage of the exhausted gases; this is sometimes referred to as electronic "TTB". The sensor is then fitted close to the flue inlet to detect spillage through increased temperature.

Used in combination with CVI electronics, this system allows an automatic restart after a predetermined time (as permitted by the European Standards) instead of complete lockout.

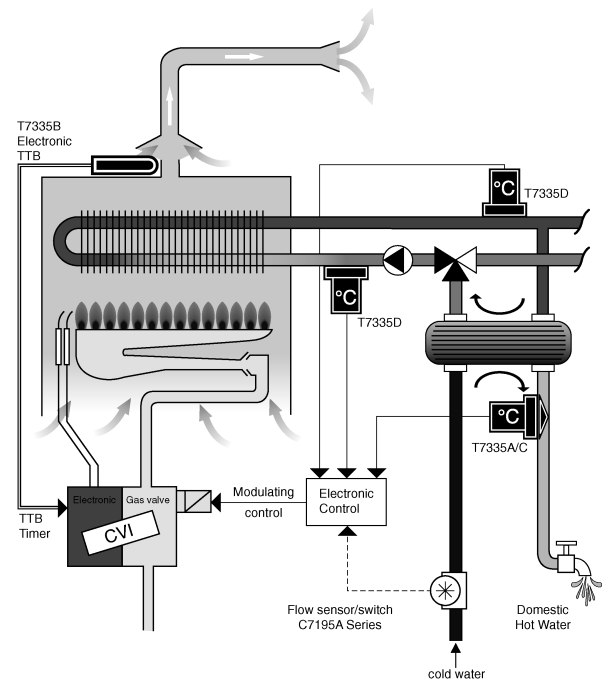

Fig. 10. Application of T7335 sensors in domestic appliances

STEINHARD AND HART EQUATION

The Steinhart and Hart equation is an empirical relation between the absolute temperature T and the NTC thermistor resistance R .

This function is expressed as:

$$\frac{1}{T(R)} = A + B \cdot \ln\left(\frac{R}{f}\right) + C \cdot \ln^3\left(\frac{R}{f}\right) [K]$$

In this, the factors A, B and C characterize a specific NTC resistor material. The factor f is used to scale the resistance values for a given NTC material to absolute values and is

defined as: $f = \frac{R_t}{R_{ref,t}}$

Here R_t is the calibrated resistance at temperature t and $R_{ref,t}$ is a reference resistance at the same temperature. To calculate the resistance R as a function of absolute temperature T use:

$$R(T) = f \cdot e^{\left\{ \sqrt[3]{-a\frac{(T)}{2} + \sqrt{a\frac{(T)^2}{4} + \frac{\beta^3}{27}}} - \sqrt[3]{a\frac{(T)}{2} + \sqrt{a\frac{(T)^2}{4} + \frac{\beta^3}{27}}} \right\}} [\Omega]$$

Where: $\alpha(T) = \frac{A - \frac{1}{T}}{C}$ and $\beta = \frac{B}{C}$

The thermistor sensitivity α_{NTC} as a function of absolute temperature is given as:

$$\alpha_{NTC}(T) = \frac{100\%}{-T^2(B + 3 \cdot C \cdot \ln^2 R(T))} \left[\frac{\%}{K} \right]$$

STANDARDS AND APPROVALS

As this T7335 thermistor temperature sensor is a single component, compliance with EMC Directive 89/336/EEC is not applicable.

The T7335 thermistor temperature sensor provides no safety control function for a heating appliance and is therefore not subject to the Gas Appliance Directive 90/369/EEC

T7335A..../C..../D.... can only be used in SELV circuits, or protective impedance circuits.

T7335B.... provides basic insulation for line voltage (1500 Vac) and can therefore only be used in SELV circuits or in appliances where the temperature sensor is not accessible.

Compliance with Low Voltage Directive 73/23/EEC can only be determined in the appliance.

ORDERING INFORMATION

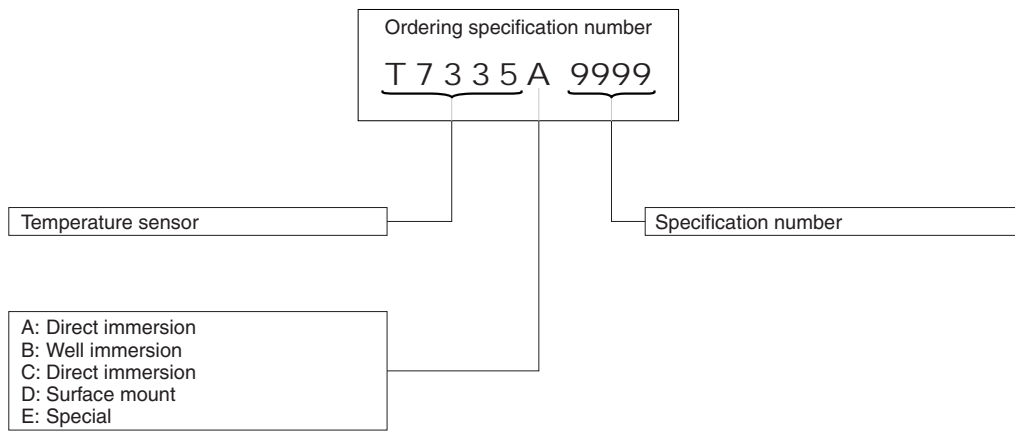

Fig. 11. Model number chart T7335 thermistor temperature sensor

ACCESSORIES

Plug for electrical connection T7335A,C,D

Lead wire length: 900

Packing quantity: 200 pcs

Ordernumber: 45.900.445-011

NOTE: The plug 45.900.445-011 provides IP 44 protection on T7335D 1 M Ω version.

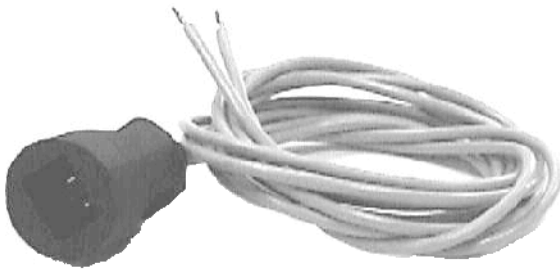

Fig. 12. Plug 45.900.445-011

Honeywell

Home and Building Control Combustion Control Center Europe

Honeywell BV

Phileas Foggstraat 7

7821 AJ Emmen

The Netherlands

Tel.: +31 (-)591 695911

Fax: +31 (-) 591 695200

<http://europe.hbc.honeywell.com>